



## Operating Instructions



# FOAMDOS V7 Foam generator

## Massage foam for hammam massages

### 230 Volt and 110 Volt design



WDT - Werner Dosiertechnik GmbH & Co. KG,  
Hettlinger Str. 17, D-86637 Wertingen-Geratshofen, Germany  
Phone: +49 82 72 / 9 86 97 – 0, Fax: +49 82 72 / 9 86 97 – 19  
[www.werner-dosiertechnik.de](http://www.werner-dosiertechnik.de), [info@werner-dosiertechnik.de](mailto:info@werner-dosiertechnik.de)

(Original installation and operating instructions)

---

## **Preface**

Dear customer,

Thank you for choosing the FOAMDOS from WDT.

FOAMDOS V7 corresponds to the latest state of the art.

Please contact us if you have any further questions. For queries and spare parts orders, please always have the device type and serial number (see identification plate on the device) at hand!

Reproduction of any kind and translation into other languages, even in excerpts, is only permitted with the express authorisation of the company WDT - Werner Dosiertechnik GmbH & Co. KG.

All rights and technical modifications reserved.

© Copyright WDT – Werner Dosiertechnik GmbH & Co KG (Edition: see footer)

---

## **Manufacturer and contact**

WDT - Werner Dosiertechnik GmbH & Co. KG

Hettlinger Str. 17

D-86637 Wertingen-Geratshofen, Germany

Phone: +49 8272 / 98697 – 0 (Switchboard)

Phone: +49 8272 / 98697 – 380 (Technical Hotline)

Fax: +49 8272 / 98697 - 19

Email: [info@werner-dosiertechnik.de](mailto:info@werner-dosiertechnik.de) – Web: [www.werner-dosiertechnik.de](http://www.werner-dosiertechnik.de)

## Table of contents

<b>1</b>	<b>About these instructions / general.....</b>	<b>5</b>
1.1	Scope of applicability .....	5
1.2	Target group.....	5
1.3	Symbols used .....	5
1.4	Further means of representation.....	6
1.5	Warranty .....	7
1.5.1	General terms and conditions of warranty .....	7
1.6	Additional information.....	7
1.7	Information regarding support queries/ identification plate .....	8
<b>2</b>	<b>Safety notices .....</b>	<b>9</b>
2.1	Intended use .....	9
2.2	Personnel .....	9
2.3	Electrical system.....	10
2.4	Operation of the device .....	10
<b>3</b>	<b>Scope of delivery / accessories/ functional description.....</b>	<b>12</b>
3.1	Scope of delivery / accessories .....	12
3.2	Product description – Structure of the overall system .....	13
3.3	Functional description.....	14
3.4	Description of components.....	14
3.4.1	Dosing unit .....	14
3.4.2	Control unit .....	14
3.4.3	Compressor .....	15
3.4.4	System separator .....	15
3.4.5	Button plate (accessory, must be ordered separately).....	15
3.4.6	Suction lance .....	15
3.4.7	Emptying valve (accessory) .....	15
3.5	Technical data .....	16
<b>4</b>	<b>Transport and storage .....</b>	<b>17</b>
4.1	General safety notices .....	17
4.2	Packaging .....	17
4.3	Temporary storage.....	17
4.4	Storage of foam concentrate .....	17
<b>5</b>	<b>Installation.....</b>	<b>18</b>
5.1	General safety notices .....	18
5.2	Select the installation site .....	19
5.3	Installation notices .....	19
5.4	Installation plan.....	19
5.5	Mechanical installation .....	20
5.5.1	Install mounting plate with control unit .....	21
5.5.2	Install the button plate .....	21
5.6	Hydraulic installation .....	22
5.7	Electrical installation .....	23
5.7.1	Safety notices.....	23
5.7.2	Open and close the housing.....	24
5.7.3	Establish electrical connection.....	24
<b>6</b>	<b>Commissioning.....</b>	<b>25</b>
6.1	General safety notices .....	25
6.2	General remarks.....	25
6.3	Commissioning steps.....	25
6.3.1	Connect the foam concentrate .....	26
6.3.2	Insert the roller carrier at the fragrance pump.....	26
6.4	Establish power supply .....	27
<b>7</b>	<b>Operation / Use .....</b>	<b>28</b>
7.1	General safety notices .....	28

7.2	Check for operational readiness.....	28
7.3	Operation .....	29
7.4	Display and controls .....	29
7.5	Switch on the FOAMDOS.....	30
7.5.1	Start query / start programme .....	30
7.5.2	Reactivating the device / operating menu .....	30
7.6	Button plate function .....	31
7.7	Control unit menus/ Display.....	31
7.7.1	General password protection.....	32
7.7.2	Activate/deactivate password protection.....	32
7.7.3	Set foam time .....	33
7.7.4	Set rinse time.....	33
7.7.5	Emptying the foam line (option) .....	33
7.7.6	Output test .....	33
7.7.7	Input test .....	35
7.7.8	Set language .....	35
7.7.9	Set contrast .....	35
7.7.10	Information about the device .....	35
7.7.11	Reset.....	36
7.7.12	Display data log .....	36
7.7.13	Config - General.....	36
7.8	Adjust the foam consistency .....	37
<b>8</b>	<b>Maintenance / Care / Fault removal.....</b>	<b>38</b>
8.1	Open/close the control housing.....	38
8.2	Device maintenance .....	38
8.3	Check/change hose kit .....	39
8.3.1	Replace hose kit and roller carrier .....	39
8.3.2	Renew hose on hose bracket .....	39
8.3.3	Dosing valves, renew valve rubber.....	40
8.4	Faults .....	40
8.4.1	General safety notices.....	40
8.4.2	Fault removal.....	41
<b>9</b>	<b>Decommissioning / Storage / Disposal .....</b>	<b>42</b>
9.1	Decommissioning .....	42
9.2	Storage .....	42
9.3	Recommissioning.....	42
9.4	Disposal .....	43
<b>10</b>	<b>Documents .....</b>	<b>44</b>
10.1	Declaration of conformity .....	44
10.2	Wiring diagrams .....	45
10.3	Commissioning protocol.....	47
10.4	Operation data sheet .....	47
10.5	Maintenance protocol.....	49
10.6	Spare parts .....	49
10.6.1	Spare parts list.....	49
10.6.2	Wear parts list .....	49
10.6.3	List of consumables .....	49
<b>11</b>	<b>Appendices.....</b>	<b>50</b>

## 1 About these instructions / general

### 1.1 Scope of applicability

These Operating Instructions describe the function, installation, commissioning and operation of the foam generator FOAMDOS V7. The Operating Instructions are an integral part of the device. The Operating Instructions must be read carefully prior to use or any maintenance work and must be kept in close proximity to the device! If the product is resold, the Operating Instructions must be handed over to the new operator.

If you lose the documentation, you can download it from our website at: [www.werner-dosiertechnik.de/Produkte/Wellness](http://www.werner-dosiertechnik.de/Produkte/Wellness)

### 1.2 Target group

Only our authorised partners and people who have been trained in the device functions are permitted to work with the device.



#### **WARNING!**

#### **Danger of electric shock!**

The device is under life-threatening voltage even during downtime! 230 Volt or 110 Volt, depending on the design.

- Electrical connection work may only be carried out by appropriately trained specialists!

### 1.3 Symbols used

This document uses the following types of safety notices as well as general notices:



#### **DANGER!**

“DANGER” denotes a safety notice which, if disregarded, will lead to serious or life-threatening injuries or death!



#### **WARNING!**

“WARNING” denotes a safety notice which, if disregarded, may lead to serious or life-threatening injuries or death!



#### **WARNING!**

#### **Danger of electric shock!**

This safety notice denotes danger due to electric shock, which, if disregarded, may lead to serious or life-threatening injuries or death!



## CAUTION!

“Caution” denotes a safety notice which, if disregarded, may lead to injuries!



## ATTENTION!

“ATTENTION” denotes a safety notice which, if disregarded, may lead to material damage or may impair the function of the device!



## ATTENTION!

### Danger due to static charge!

This safety notice denotes electronic components that may be damaged by electrostatic discharges.

The generally accepted safety precautions for ESD-sensitive devices must be observed when handling the devices!



## NOTICE

A “Notice” denotes information that is of particular importance for the smooth running of operations and that can disrupt the operating process if not observed.



## TIP

A “TIP” denotes information that may result in improvements in the operating process.



## USE HAND PROTECTION!

Wear approved hand protection to avoid irritation or allergic reactions due to contact with hot or chemical substances (according to DIN EN 374: Protective gloves against dangerous chemicals and micro-organisms).



## USE FOOT PROTECTION!

Wear approved foot protection to prevent injuries to the feet due to contact with hot or chemical materials.

### 1.4 Further means of representation

The means of representation used in these instructions denote the following:

- General enumeration
- a) Work or operating steps that should or must be carried out in the order listed.
- 01.** Numbering of elements (item numbers)
- Step that needs to be checked in particular

*Italics* Labelling of illustrations or references

## 1.5 Warranty

All WDT devices and systems are manufactured using modern production methods and are subject to comprehensive quality control. However, should there be a reason for complaint, any compensation claims shall be directed to the company WDT in accordance with the general terms and conditions of warranty.

### 1.5.1 General terms and conditions of warranty

The company WDT assumes a 2-year warranty, starting with the commissioning, up to 27 months after delivery; subject to correct installation and commissioning with a completed and signed commissioning protocol.

Exempt from this are wear parts such as seals, hoses, diaphragms, dosing screws, electrodes, roller carriers and other parts that are subject to mechanical or chemical wear and tear. For these we assume a warranty of 6 months.

Our enterprise resource planning system requires an invoice for each delivery (including warranty services). When returning a defective component, upon review you will receive a corresponding credit, if applicable. We request a return within 14 days.

The costs for subsequent damage and for the processing of warranty claims are excluded.

There are no warranty claims for damage caused by frost, water and electrical overvoltage or by improper handling.



#### CAUTION!

**In the event of any unauthorised modifications to the device, the warranty and product liability will be voided!**



#### NOTICE

For the safeguarding of any warranty claims, please send the completed commissioning protocol, together with the defective component.

Without the commissioning protocol, we reserve the right to an exclusion of warranty.

It is not permitted to make any modifications to the device. If this specification is not observed, the warranty obligation and product liability will expire!

## 1.6 Additional information

Additional information concerning specific topics, such as the description of the operating parameters, may be obtained from your specialist dealer, or directly from:

WDT – Werner Dosiertechnik GmbH & Co. KG

Hettlinger Str. 17

D-86637 Wertingen-Geratshofen, Germany

Phone: +49 8272 / 98697- 0 (Switchboard)

Phone: +49 8272 / 98697- 380 (Technical Hotline)

Fax: +49 8272 / 98697 - 19

Web: [www.werner-dosiertechnik.de](http://www.werner-dosiertechnik.de)

Mail: [info@werner-dosiertechnik.de](mailto:info@werner-dosiertechnik.de)

## 1.7 Information regarding support queries/ identification plate

The control unit of the FOAMDOS V7 is subject to continued further development of both its firmware and hardware. We always strive to preserve the compatibility of the components.

For spare part orders, we require the following data. These can be found on the identification plate.

- Device designation, device serial number, year of manufacture

Enter the data from your device's identification plate here.

Field 1: Enter code number

Field 2: Enter serial number

Field 3: Enter date of manufacturing

### 230 Volt device

<b>Typ: FOAMDOS V7</b>	
Art.: <input type="text"/>	Serien Nr.: <input type="text"/>
230 V/AC	Imax. 3,15 A
Herstellung: <input type="text"/>	
 WDT - Werner Dosiertechnik GmbH & Co. KG Hettlinger Str. 17 D-86637-Wertingen Made in Germany	

### 110 Volt device

<b>Typ: FOAMDOS V7</b>	
Art.: <input type="text"/>	Serien Nr.: <input type="text"/>
110 V/AC 60Hz	Imax. 3,15 A
Herstellung: <input type="text"/>	
 WDT - Werner Dosiertechnik GmbH & Co. KG Hettlinger Str. 17 D-86637-Wertingen Made in Germany	

In addition, we require the following data for technical support queries. These are located in the menu item **Menu ▶ Service ▶ Info**.

- current software version
- Serial number



### **NOTICE**

Keep the identification plates clean and in a legible condition!



## 2 Safety notices

### 2.1 Intended use

The FOAMDOS dosing device is used to produce a massage foam for body care during hammam massages.

Also pay attention to the locally applicable regulations concerning accident prevention, occupational safety and drinking water protection!



#### CAUTION!

##### Health hazard due to unsuitable foam concentrate!

- Only use suitable foam concentrate.



#### ATTENTION!

##### Damage to the device due to incorrect installation!

- Pay attention to the information in the technical data on page 15.

Intended use also includes compliance with all conditions and safety instructions prescribed by WDT in accordance with these instructions for:

- Installation
- Dismantling
- Reinstallation after decommissioning
- Commissioning
- Operation
- Maintenance/servicing
- Disposal.

The attachment or installation of additional equipment is only permitted with the manufacturer's written approval.

Pay attention to the nationally applicable regulations for environmental and drinking water protection!

### 2.2 Personnel



#### WARNING!

##### Restricted user group!

**This device is not intended to be used unsupervised by persons (including children) with reduced physical, sensory or mental capabilities, or lack of experience and/or knowledge.**

- A person responsible for the safety of this group of users must be entrusted with supervision and must give appropriate instructions for operation.
- Children must be supervised to ensure that they do not play with the device!

Work on the device and changes in the settings may only be carried out by properly instructed persons and persons who have read and understood the Operating Instructions!

The personnel must be informed by the operator of any hazards that may occur. A copy of the Operating Instructions must be left at the device's place of use.

Persons who transport or work on and with the device must have read and understood the relevant parts of the Operating Instructions, and in particular the chapter "Safety notices" starting on page 9.

Pay attention to the nationally applicable regulations for accident prevention and work safety!

## 2.3 Electrical system



### WARNING!

#### Danger of electric shock!

Dangerous electrical voltage! 230 Volt or 110 Volt, depending on the design

- All work on the device must be carried out by specialist personnel only!
- All electrical installations and any work on the device's electrical components must be carried out by authorised electricians only!
- Prior to starting work, disconnect the device from the power supply and secure it against being reactivated!
- After corresponding electrical installation or repair, test all protective measures used (e.g., earthing resistance)!



### ATTENTION!

#### Damage to the device due to an unsuitable fuse!

- Use only the original fuses with the prescribed current rating!
- Regularly check the device's electrical equipment!
- Immediately eliminate defects such as loose connections, scorched cables or damaged electrical insulation!

The installing specialist company is responsible for an intrinsically safe installation of the WDT FOAMDOS.

## 2.4 Operation of the device



### WARNING!

Pay attention to all of the safety and warning notices located on the device!



### CAUTION!

#### Health hazard due to unsuitable foam concentrate!

- Only use suitable foam concentrate.



## ATTENTION!

**Damage to the device due to repeated switching on without rectifying the fault!**

- Carefully read and pay attention to the operating instructions prior to installation and use of the device!
- In the event of malfunctions or faults in the electrical power supply, immediately switch off the device and secure it against being switched on again!
- Faults on the device must be rectified immediately!

All protection and warning devices must be tested regularly in order to ensure proper function. The device must be checked regularly according to the enclosed maintenance protocol.



## WARNING!

**Danger due to switched-off safety devices!**

The device is equipped with numerous safety devices to protect your health.

- Never remove or deactivate safety devices during operation!
- Never operate the device without functioning safety devices!

## 3 Scope of delivery / accessories/ functional description

### 3.1 Scope of delivery / accessories

The delivery consists of a ready-to-connect dosing device FOAMDOS V7, consisting of:

- Micro-processor control unit CB36 inside the control housing
- Diaphragm pump/ compressor 7006 AC
- Inlet with ball valve 1/2" IG and filter MS 1/2"
- System separator in accordance with EN1717
- Pressure reducer for regulating the system pressure
- Needle valve for regulating the water flow during foam generation
- 2 solenoid valves 3/8" (for rinsing and foam generation)
- Foam generator for foam generation
- Peristaltic pump SA
- Suction lance d 12-420 mm
- 2 x dosing valve for foam concentrate and air
- Hose PVC 12 x 1.5 transparent for foam dispenser
- Completely pre-assembled and pre-wired on mounting plate PP grey
- Transition nipple for foam line from 3/8" to 1/2"

#### On-site services

- Technical room/ cabinet for installation of the control panel; alternatively: Installation below the massage table
- Isolated ground socket for 110 Volt or 230 Volt, depending on the device design
- Thermostatic mixer / mixed water connection 1/2"
- Required pressure at the transfer point: min. 1.5 bar flow pressure
- Water volume: approx. 10 l/min
- Drain DN40 / gully in the technical room

#### Accessories/ options

- Thermostatic mixer for the correct water temperature during the rinsing function
- Button plate 2-fold (different designs, aluminium, corian, stainless steel, etc.) and flush-mounted box
- Hand-held shower head for foam outlet
- Shower head hose
- Emptying valve (solenoid valve)
- Foam concentrate



#### **NOTICE**

When receiving the device, ensure that:

- the type and serial number on the identification plate correspond to the details in the ordering and delivery documents, and
- the equipment is complete and all parts are in perfect condition.

In the event of any transport damage and/or missing parts, **immediately notify the forwarding agent or supplier in writing.**

Pay attention to the deadlines for notifying the transport companies for the purpose of assessing damage.

## 3.2 Product description – Structure of the overall system

### Overview FOAMDOS V7

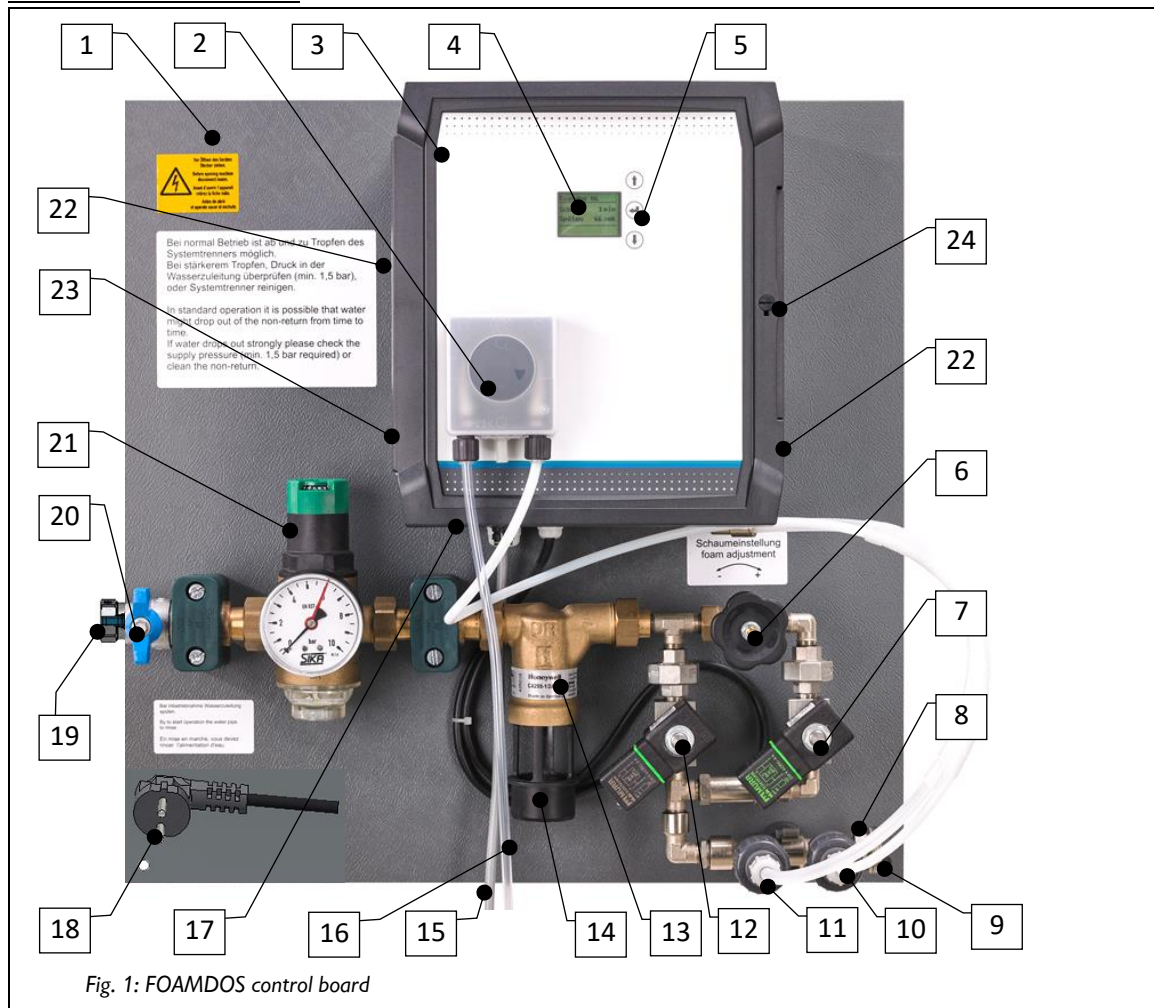

### Key

01. Mounting plate	02. Peristaltic pump
03. Control housing with built-in compressor	04. Display
05. 3 buttons for operating the display	06. Needle valve, adjusting the foam consistency
07. Solenoid valve for foam generation	08. Foam generator (porous insert)
09. Outflow / connection foam line (position for Emptying valve, option)	10. Dosing valve foam concentrate with hose line
11. Dosing valve air with hose line	12. Solenoid valve rinsing
13. System separator	14. Connection water drain on the system separator d40 mm
15. Power cable with mains plug	16. Suction line to the foam concentrate container
17. Socket for button plate	18. Safety plug or NEMA plug
19. Inlet 1/2", connection to house water line (tempered water)	20. Shut-off valve
21. Pressure reducer with manometer and water filter	22. Ventilation grille 2x (covered)
23. Mains switch (covered)	24. Opening mechanism control housing

The FOAMDOS V7 dosing device is delivered in 2 different variants. A **230 V/50 Hz design** and a **110 V/60 Hz design**. Both variants are described in these instructions.

### 3.3 Functional description

The FOAMDOS dosing device produces a massage foam from 3 components (water, air and foam concentrate), which is applied to the guest during hammam massages. The massage foam can also be used for body care during the steam bath. A rinsing function is integrated. The water flow and thus the consistency of the applied foam can be individually adjusted on the device by means of a needle valve.

Foam generation and rinsing can be switched on and off separately at the external button plate. After switching off the rinsing, the compressor continues to run for a preset time in order to blow out the line (optionally adjustable).

Settings in the programme can be made on the LCD display.

### 3.4 Description of components

#### 3.4.1 Dosing unit

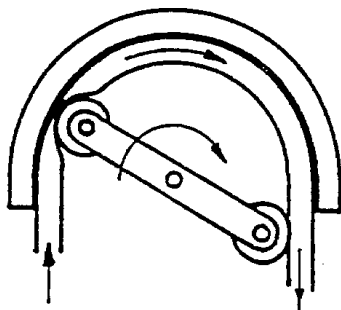

Fig. 2: Peristaltic pump function



Fig. 3: Dosing valve

A peristaltic pump is used for dosing the foam concentrate. Peristaltic pumps are able to transport even the smallest dosing quantities reliably and evenly, even when air or gas bubbles are trapped in the suction line. Rotating rollers press the dosing hose against the casing wall, which pushes the liquid in the hose out in front of the rollers while simultaneously suctioning again behind them. The peristaltic pump is exceptionally reliable and also very easy to operate.

The standard installation of a dosing valve with a non-return safety device reliably prevents water from being pushed back or the dosing line from running empty. The opening pressure is 0.5 barg.

## ATTENTION!

**The dosing hose must be checked at regular intervals in order to detect any damage in a timely fashion. See also maintenance protocol**

#### 3.4.2 Control unit



Fig. 4: Control unit

The control unit is available in 2 different designs. A 230 V/50 Hz design and a 110 V/60 Hz design.

The control unit consists of a housing with openings on the side for cooling the built-in compressor. The electronic components are installed in the housing. The operating parameters are set at the control unit.

## 3.4.3 Compressor

The compressor is installed in the control housing. It pumps air into the foam generator via a dosing valve. Together with the foam concentrate and the water, the massage foam is created in the foam generator.

## 3.4.4 System separator

The built-in system separator in accordance with DIN EN 1717 ensures that no water mixed with soap can be sucked into the piping system in the event of a pressure drop.

## 3.4.5 Button plate (accessory, must be ordered separately)



Fig. 5: Button plate, sample illustration

Button plate with flush-mounted box for starting the foam generation, starting the rinsing or stopping the programme.

For details about the flush-mounted box, see supplementary sheet “**BB DW 001-03 Installation flush-mounted box V2**” in *Chapter 11*

### **Additional options:**

- Button plate made of stainless steel or corian
- Steam room button

## 3.4.6 Suction lance



Fig. 6: Suction lance

The suction lance is used to suck the foam concentrate out of the canister. The suction lance is screwed on in place of the canister lid and can be adjusted in height.



### **TIP!**

**If the thread of the suction lance does not fit the delivery container, the canister lid of the delivery container can be used.**

## 3.4.7 Emptying valve (accessory)

The Emptying valve is optionally available as an accessory. The Emptying valve can drain the water in the foam line if there is a difference in height between the dosing device and the dosing point. Emptying can be done in both directions.

## 3.5 Technical data

	FOAMDOS V7 230 Volt	FOAMDOS V7 110 Volt
<b>Dimensions and weights:</b>		
External dimensions	500x500x200 mm(WxHxD)	500x500x200 mm(WxHxD)
Space requirement	700x1000x300 mm(WxHxD)	700x1000x300 mm(WxHxD)
Space requirement, including operation and maintenance	700x2000x1000 mm(WxHxD)	700x2000x1000 mm(WxHxD)
Empty weight/operating weight	10 kg / 10 kg	10 kg / 10 kg
<b>Connection data</b>		
Water inlet	1/2" interior thread	1/2" interior thread
Foam drain	3/8" / interior thread / pipe union	3/8" / interior thread / pipe union
Electrical connection	230 VAC/50 Hz, 150 W, safety plug	110 VAC/60 Hz, 150 W, NEMA plug
Fuse F2	1 A slow, D8,3x8 on CB36	1 A slow, D8,3x8 on CB36
Fuse F9	4 A slow, D8,3x8 on CB36	4 A slow, D8,3x8 on CB36
Nominal pressure house connection	min. 1.5 barg, max. 8 barg	min. 1.5 barg, max. 8 barg
Recommended operating pressure at the pressure reducer	Max. 4 barg	Max. 4 barg
Required duct connection	d40 mm	d40 mm
Protection class	IP44	IP44
<b>Operating data:</b>		
Foam time	0 - 10 minutes	0 - 10 minutes
Rinse time	0 – 10 minutes	0 – 10 minutes
Emptying time	0 – 59 seconds	0 – 59 seconds
Container size foam concentrate	10 l	10 l
Foam output	2.6 l/min	2.6 l/min
Peristaltic pump	140 ml/min.	140 ml/min.
Solenoid valves	1/4" interior thread, 230 VAC	1/4" interior thread, 110 VAC
Control unit	230 VAC/50 Hz	110 VAC/60 Hz
Medium temperature	5°C to 45°C	5°C to 45°C
Ambient temperature technical room	5°C to 35°C	5°C to 35°C
Humidity technical room	max. 70%	max. 70%
Ventilation (in and out)	Recommended for the technical room	Recommended for the technical room

Table 1: Technical data



## 4 Transport and storage

### 4.1 General safety notices



#### ATTENTION!

#### Damage to the device due to an unsuitable transport!

- Please check the device immediately upon receipt for potential transport damage
- The device must only be transported in its original packaging!
- When transporting the WDT FOAMDOS, proceed with caution to prevent damage due to force or careless loading and unloading.
- The device must be emptied, cleaned and dried for storage.
- Avoid exposure to frost during transport!

### 4.2 Packaging



#### WARNING!

#### Danger of suffocation!

- Keep packaging and packaging residue, in particular plastic bags, away from children!



#### NOTICE

Pay attention to the notices and pictograms on the carton!

### 4.3 Temporary storage



#### ATTENTION!

#### Damage to the device due to an unsuitable storage!

The device may be damaged by frost or high temperatures!

- Avoid exposure to frost during storage!
- Remove the roller carrier from the peristaltic pump to avoid any deformation of the hose.
- Do not store systems and devices next to objects with strong heat emission or in direct sunlight.
- The device must only be stored empty, cleaned and dried.
- The device must only be stored in its original packaging. Please ensure careful handling.

### 4.4 Storage of foam concentrate

#### CAUTION!

Pay attention to the foam concentrate manufacturers' data sheets regarding storage as well as the local regulations for work safety and for environmental and drinking water protection!

Pay attention to the following points, among others:

- The foam concentrate must only be stored in the appropriately identified original plastic containers.

## 5 Installation

### 5.1 General safety notices



#### **WARNING!**

#### **Risk of injury!**

Personnel who are not familiar with professional installation methods may suffer bodily harm!

- The installation of this device may only be carried out by qualified personnel (persons who have completed training in the field of sanitation or in the field of electrical installation)!



#### **WARNING!**

#### **Danger of electric shock!**

Dangerous electrical voltage! 230 Volt or 110 Volt, depending on the design

- All work on the device must be carried out by specialist personnel only!
- All electrical installations and any work on the device's electrical components must be carried out by authorised electricians only!
- Prior to starting work, disconnect the devices from the power supply and secure them against being reactivated!
- After corresponding electrical installation or repair, test all protective measures used (e.g., earthing resistance)!



#### **CAUTION!**

#### **Danger of foot injuries!**



The device can fall down when installed by a single person!

- Always carry out the installation with 2 persons!

WDT accepts no liability for damage caused by incorrect installation!

The attachment or installation of additional equipment is only permitted with the manufacturer's written approval; otherwise any warranty will be voided.

## 5.2 Select the installation site



### ATTENTION!

#### Damage to the device due to an unsuitable installation site!

- Outdoor installation is not permitted

#### The installation site must have the following properties:

- The installation site must be frost-proof.
- The device must be protected from direct sunlight.
- An electrical power connection with a safety contact is required.
- A waste water connection must be available (for system separation), at least d40mm.
- A ½" waste water connection must be available.
- Space must be available for foam concentrate 10 l canister 240x320x190 (WxHxD)

## 5.3 Installation notices

The device is installed at a wall in the technical room or below the massage table. The foam concentrate is located under the FOAMDOS. Pay attention to the space required for operation and maintenance of the device, see *Chapter 3.5 Technical data*.

- Warning and information signs must be installed in compliance with locally applicable accident prevention regulations at the locations provided!
- Do not bend the dosing and foam lines

## 5.4 Installation plan

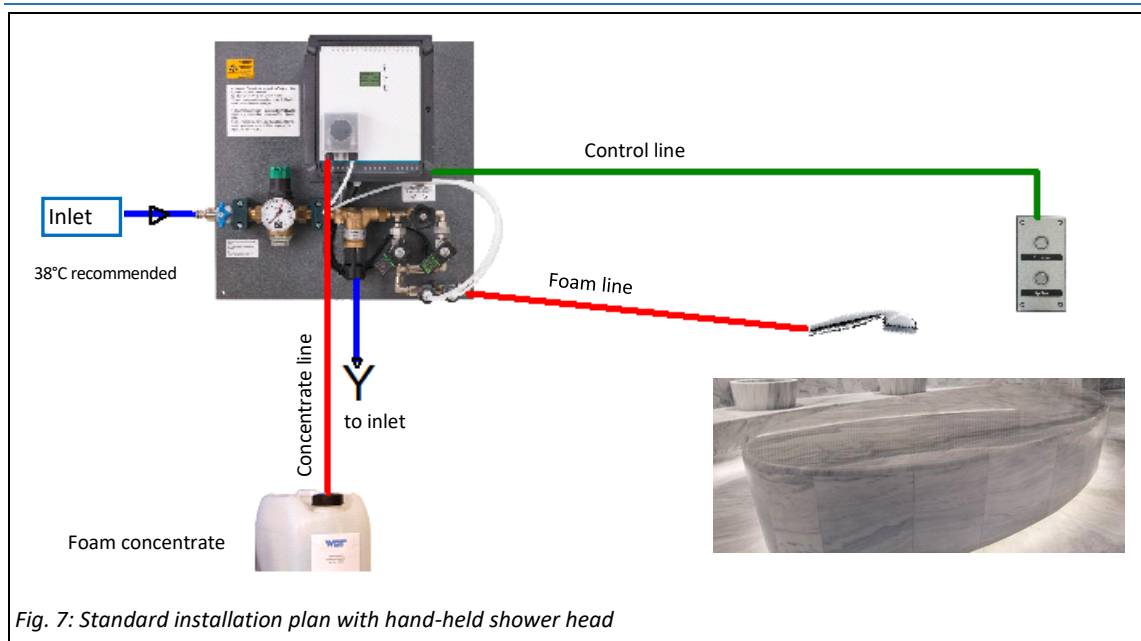
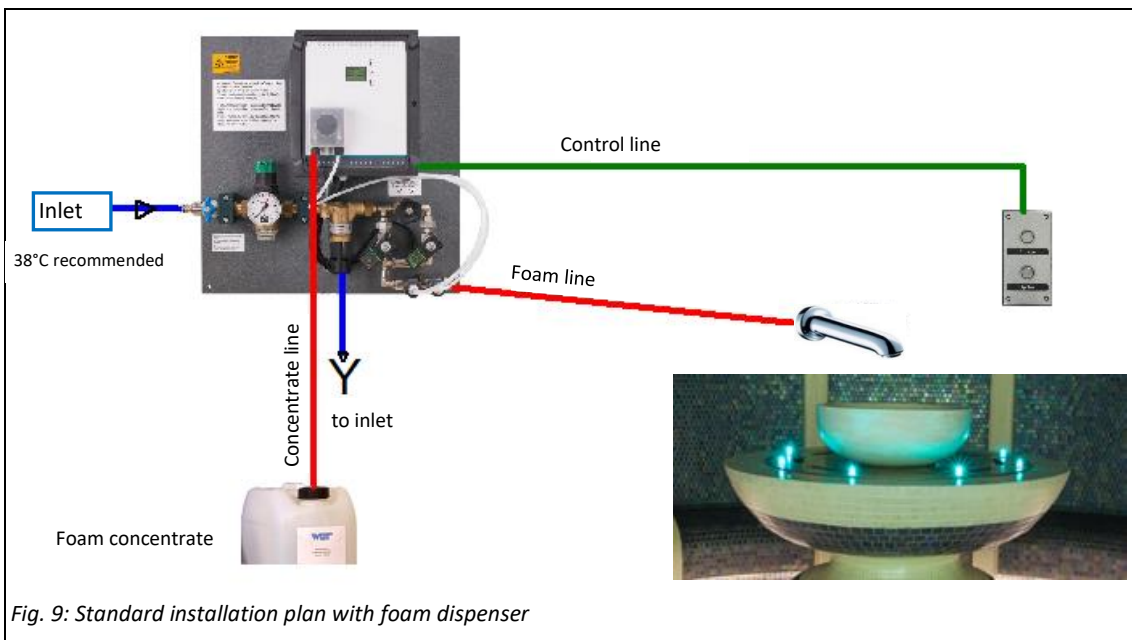
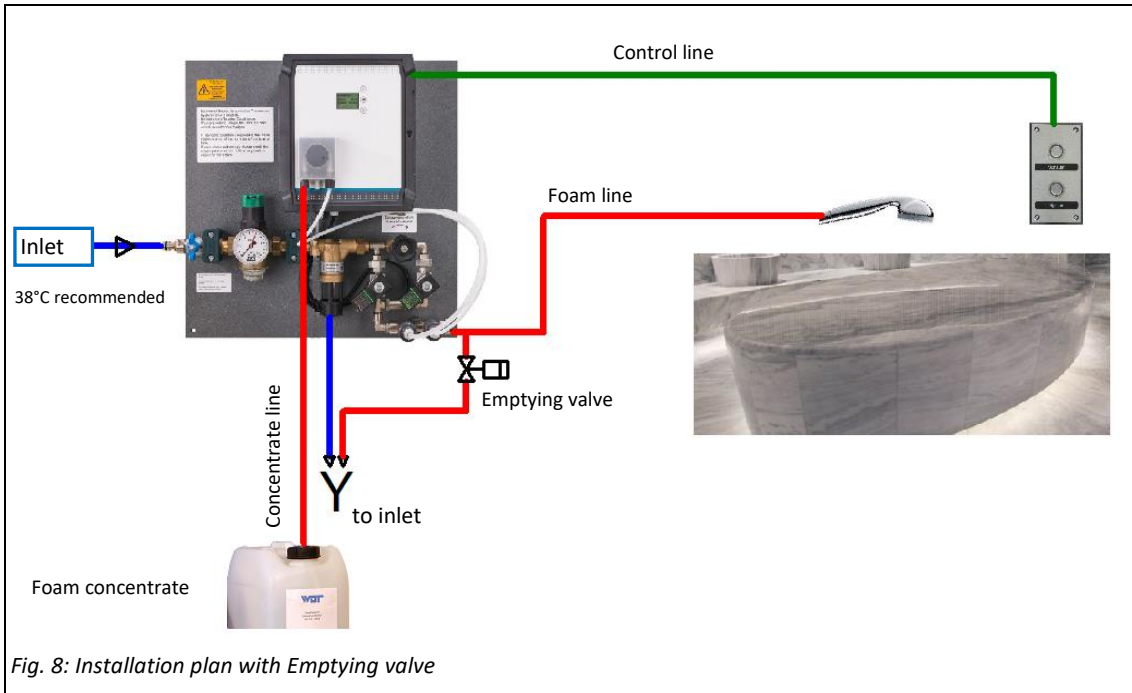

Fig. 7: Standard installation plan with hand-held shower head



## 5.5 Mechanical installation



### CAUTION!

#### Danger of foot injuries!



The device can fall down when installed by a single person!

- Always carry out the installation with 2 persons!

With the exception of the roller carrier and the foam concentrate, the FOAMDOS is delivered ready for operation. It should be installed in an easily accessible location.

Securely attach the mounting plate to the wall with 4 screws and ensure easy accessibility.



## ATTENTION!

### Damage to the device due to unsuitable wall attachment!

At unsuitable walls (e.g., porous or unstable) or with inadequately dimensioned fastening material (e.g., screws that are too short or unsuitable dowels), the device may detach from the wall!

- Pay attention to the device's operating weight according to the technical data on *page 15!*
- The wall and the fastening material must be able to bear the specified operating weight!

#### 5.5.1 Install mounting plate with control unit

Install the FOAMDOS dosing device at working level in the technical room. It is also possible to install the dosing device below the massage table.

##### Procedure

- When selecting the installation site, make sure it is easily accessible.
- Attach the mounting plate to the wall using 4 screws.



#### TIP

During installation, ensure short connection paths for the water connections. The longer the foam line, the more the foam is compressed in the line. This reduces the foam volume.

#### 5.5.2 Install the button plate



Fig. 10: Button plate 2-fold, sample image

Install the button plate on or next to the hammam bench or the foam collection tray. In the vicinity of the foam dispenser or the shower head.

Install the flush-mounted box for the button plate. For installation details, see supplementary sheet "BB DW 001 Installation flush-mounted box V2" in *Chapter 11, Appendices*.

- The push button cable (standard 7 m) is equipped with a plug. In order to be able to lay the cable, we recommend installing an empty pipe with a diameter of 32 mm from the control unit to the button plate.
- During installation, make sure that the empty pipe is not angled, but laid in bends with a radius of at least 30 cm.
- Pull in the plug-ready push button cable.



## ATTENTION!

Seal the button plate against the wall with a suitable sealant to prevent humidity from penetrating behind the button plate.

## 5.6 Hydraulic installation



### **NOTICE!**

To prevent dirt in the house water line from entering the device, the house water line must first be rinsed. Then connect the supply line of the device to the house water line.

The rinsing of the house water line must be recorded by the installer in a handover protocol.

To prevent limescale deposits, we generally recommend using softened water (4° German hardness).

#### Connect the inlet line

For the connection of the inlet line, we recommend tempered water or a thermostatic mixer to ensure a comfortable water temperature for rinsing.

- a) Install the inlet line to the dosing device.

#### Connect the foam line

The foam line should be as short as possible; a maximum of 10 m is possible. The foam line should have an inside diameter of 10-13 mm.

The foam line from the dosing device to the foam dispenser can be connected in 2 different variants:

1. Standard foam line

- a) Install the foam line from the device up to the wall mounting bend for the shower hose of the hand-held shower head.
- b) Connect the shower hose and the hand-held shower head to the wall mounting bend.

2. Foam line with Emptying valve



### **NOTICE**

If the Emptying valve is ordered together with a FOAMDOS, it is already installed at the factory.

If the foam line must be installed at an incline or decline and exceeds a length of 5 m, the use of a Emptying valve (accessory) is recommended.

- a) Install the foam line with a branch for the Emptying valve, from the device up to the wall mounting bend for the shower hose of the hand-held shower head.
- b) Install the Emptying valve in such a way that the line can run empty. This prevents cold water from coming out of the foam line during the next operation.
- c) Connect the Emptying valve to the waste water pipe via a funnel drain (pay attention to system separation).
- d) Connect the shower hose and the hand-held shower head to the wall mounting bend.

## Variants for the foam dispenser

The foam dispenser is available in the following designs:



01. As a movable hand-held shower head (option)



02. As a fixed foam dispenser (on-site service)

Fig. 11: Hand-held shower head and foam dispenser, sample images

Connect the drain line

- a) Install the line from the system separator to drain, at least d40 mm

## 5.7 Electrical installation



### ATTENTION!

The electronic components in the devices are sensitive to electrostatic discharges. The generally accepted safety precautions for ESD-sensitive devices must be observed when handling the devices.

The following applies, in particular:

- Plug-in connectors must only be connected or removed when the power has been deactivated.
- Before touching electrical components inside the device, the person handling it must electrostatically discharge themselves for at least 5 seconds. For example, by touching an earthed system part or by wearing an ESD antistatic wrist strap connected to an earth wire.

### 5.7.1 Safety notices



### WARNING!

#### Danger of electric shock!

Dangerous electrical voltage! 230 Volt or 110 Volt, depending on the design

- All work on the device must be carried out by specialist personnel only!
- All electrical installations and any work on the device's electrical components must be carried out by authorised electricians only!
- Prior to starting work, disconnect the devices from the power supply and secure them against being reactivated!
- After corresponding electrical installation or repair, test all protective measures used (e.g., earthing resistance)!

## 5.7.2 Open and close the housing

The housing does **not** need be opened for electrical connection.

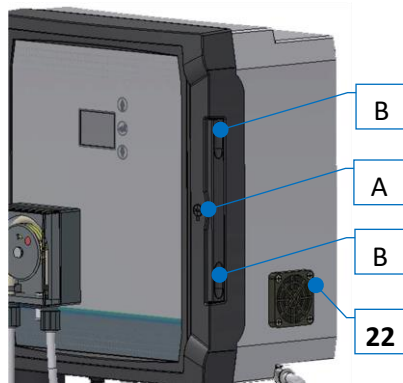

Fig. 12 Open control housing

### **Open housing**

- Unlock the locking knob (A) with a screwdriver.
- Press down on both recessed grips (B) until the housing snaps open.
- Rotate cover open.

### **Close the housing**

- Close cover. The recessed grips (B) must snap shut.
- Lock the locking knob (A) with a screwdriver.

## 5.7.3 Establish electrical connection

### **230 Volt design**

The FOAMDOS is connected to the power supply (230 V, 50 Hz) with the safety plug.

### **110 Volt design**

The FOAMDOS is connected to the power supply (110 V, 60 Hz) with the mains plug (NEMA-5, type B).

### **Procedure**

- Ensure that the power socket is earthed.
- Switch off the mains switch on the device.
- Connect the button plate's plug to the device.
- Insert the mains plug into the power socket.



## 6 Commissioning

---

### 6.1 General safety notices

---



#### WARNING!

#### Risk of injury!



#### Injury to fingers (crushing) possible!

- Prior to starting work, read and understand the Operating Instructions!
- Wear gloves!
- Ensure that the protective cover of the peristaltic pump is installed.
- The tasks described here must only be performed by appropriately qualified personnel from a specialist company.
- Prior to commissioning, the devices must be checked for proper installation and leaks.



#### ATTENTION!

#### Damage to the device due to incorrect commissioning!

- The sequence of the following commissioning steps must be observed!
- The information in the commissioning protocol must be observed!

### 6.2 General remarks

---

During commissioning, a distinction is made between

- initial commissioning following installation
- recommissioning following canister replacement or after extended downtime

The device comes loaded with ex works settings.

Adjust the control parameters to the desired operating mode during initial commissioning and enter them in the operation data sheet in *Chapter 10.4 on page 47*.

### 6.3 Commissioning steps

---

Ensure that the device has been correctly installed and connected.

## 6.3.1 Connect the foam concentrate

### Procedure

- a) Place the canister with the foam concentrate under the device.
- b) Remove the canister lid.
- c) Place the suction lance in the canister.
- d) Screw the suction lance's lid on the canister. If necessary, replace the suction lance's lid.
- e) Check that the suction lance reaches the bottom of the canister.
- f) If necessary, push suction lance downward.

## 6.3.2 Insert the roller carrier at the fragrance pump



### WARNING!

#### Risk of crushing!



#### Injury to fingers (crushing) possible!

- Only conduct the work when the device has been switched off and secured against being reactivated!



### ATTENTION!

#### Faulty operation due to an unsuitable hose!

The peristaltic pump is fitted with a white dosing hose. Dosing hoses with other colours are made of different material and may have different dimensions. This may lead to faulty operation! Only use original dosing hoses.

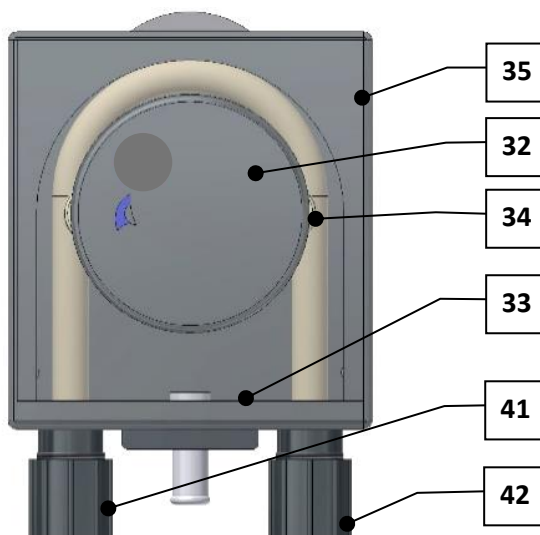

- 31 Transparent pump cover (not shown)
- 32 Safety disc
- 33 Hose bracket with dosing hose
- 34 Roller carrier (not visible)
- 35 Pump casing
- 41 Suction connection
- 42 Pressure connection

- a) Remove the clipped-in transparent pump cover (Fig. 13, no. 31) and the safety disc (Fig. 13, no. 32) from the pump casing (Fig. 13, no. 35).

At initial commissioning, these parts can be found loose in the enclosed bag.

- b) Pull the hose bracket (Fig. 13, no. 33) out of the guide in the housing.

Fig. 13: Peristaltic pump



Fig. 14: Insert roller carrier

- c) Push the *roller carrier* (Fig. 13, no. 34) onto the shaft.

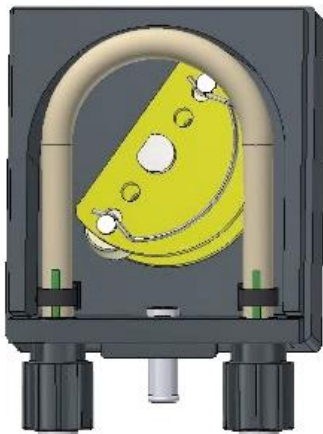

Fig. 15: Insert the hose bracket

- d) Insert the *hose bracket* (Fig. 13, no. 33) into the housing guides until it locks into place completely.

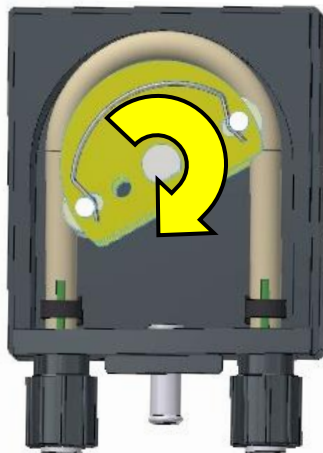

Fig. 16: Turn the roller carrier

- e) Turn the *roller carrier* (Fig. 13, no. 34) clockwise and carefully press the hose into the housing at the **roller carrier's flat side** until the entire hose is contained in the housing.
- f) Now replace the safety disc and the transparent pump cover.
- The installation of the roller carrier is now completed.
- The roller carrier and hose bracket are **disassembled** in the reverse order.

## 6.4 Establish power supply

### Procedure

- Ensure that all installation work has been completed.
- Insert the mains plug into the power socket.

## 7 Operation / Use

---

### 7.1 General safety notices

---



#### **WARNING!**

#### **Health hazard due to incorrect operation!**

- Pay attention to all safety notices in these instructions, in particular the safety notices in the chapter 2 on page 9!
- The device must not be put into operation until the installation (mechanical, hydraulic and electrical) and the commissioning have been completed!
- The device must only be operated by trained and instructed personnel!
- Prior to operation, the operating personnel must have completely read and understood these instructions!



#### **WARNING!**

#### **Risk of crushing!**

**Injury to fingers (crushing) possible!**

- Ensure that the protective cover of the peristaltic pump is installed.

### 7.2 Check for operational readiness

---

- Check whether the power supply is ensured; connect the device, if necessary.
- Check the foam concentrate level in the canister; replace canister, if necessary.
- Check connections and peristaltic pump for leaks; restore proper seal, if necessary.

## 7.3 Operation

The device is operated via 3 operating buttons next to the display.  
The start push button is located on the button plate.

### Overview control unit

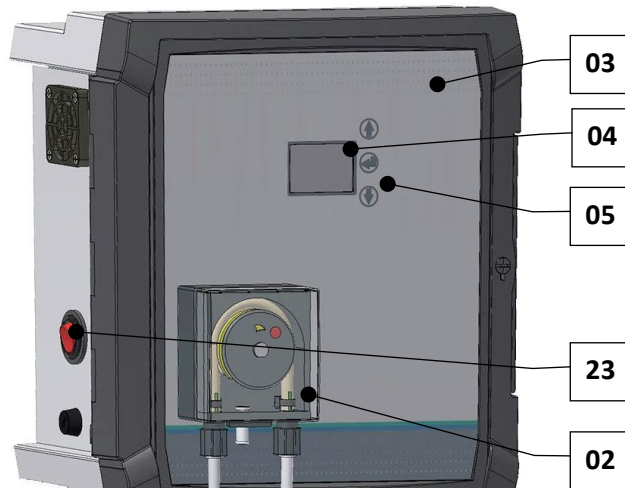

Fig. 17: Control unit with display

### Key

02 Peristaltic pump

03 Control housing with built-in compressor

04 Display

05 3 buttons for operating the display:

#### **Navigation upwards**

Use the arrow key to navigate upwards, enter the operating menu or set numerical values.

#### **Enter key**

Use the Enter key to navigate to the selected submenu or to the next setting value.

#### **Navigation downwards**

Use the arrow key to navigate downwards or set numerical values.

23 Mains switch

## 7.4 Display and controls

There are 3 operating buttons next to the LCD display. Use the operating buttons to navigate in the menu.



### **NOTICE**

The display had a dim function.:

If no input occurs for **60 seconds**, the backlighting is dimmed. The background illumination is reactivated by pressing a key (arrow keys, Enter key).

## 7.5 Switch on the FOAMDOS

Switch on the device at the mains switch.

### 7.5.1 Start query / start programme



#### **NOTICE**

When the device is switched on for the first time, or after a reset, the device starts automatically with the start query.

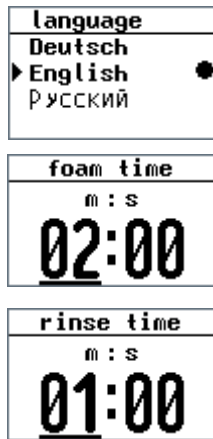

Fig. 18: Display with operation display

After switching on the device for the first time, or after re-setting it to the factory settings, the language and the parameters for foam time and rinse time must first be entered. The corresponding menus are shown in sequence.

After successful entry, the display switches to the operating menu, and the device is ready for operation.

### 7.5.2 Reactivating the device / operating menu

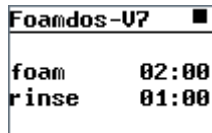

Fig. 19: Display with operating menu

After reactivation, the device starts in the **operating menu and is immediately ready for operation.**

The display is illuminated.

The display shows the set times for the foam time and rinse time.

The header contains an additional symbol for current operation settings

Symbol	Description
□	Operating contact open → The device's foam function is locked. The device is switched in standby mode. It is only possible to call up the test programmes and read and change the parameters.
■	Operating contact closed → The device works as described in the instructions

## 7.6 Button plate function



Fig. 20: Button plate, sample illustration

### Start/stop the programme

#### Foam generation:

- a) Press the “Foam” push button. Foam generation runs for the set time.
- b) Pressing the push button again stops the foam generation prematurely.
- a) **Rinsing** Press the “Rinse” push button. The rinse time runs for the set time. The button then flashes for the set Emptying time (only when Emptying is activated).
- b) Pressing the push button again stops the rinse time prematurely.

### Restart the programme

If a push button is pressed again after the time has elapsed, the programme starts again.



### NOTICE

A push button prompt is only possible when the display shows the operating menu. The push button prompt is locked in the main menu.

## 7.7 Control unit menus/ Display

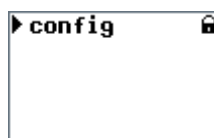
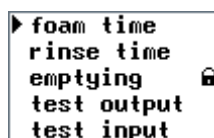
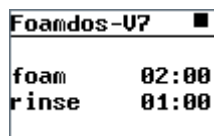











Fig. 21: Menu sequence

The menu of the control unit is simply structured and easy to operate. It consists of the operating menu and the main menu, which can be reached via the arrow keys  and . Use the arrow key  to navigate back to the main menu via the foam time.

Pressing any Key (Fig. 17, no. 72) in the operating menu opens the main menu. Navigation is done via the arrow keys  and .

01. Foam time
02. Rinse time
03. Emptying 
04. Test output
05. Test Input
06. Language 
07. Contrast
08. Info
09. Reset 
10. Data log
11. Config 

The black triangle on the left-hand side of the menu marks the currently selected list item.

The list entry is selected using the Enter key .

There are menu items that are marked with a padlock symbol . These menus can only be changed by entering the user password.



## NOTICE

The time you switch to the main menu, the operation of the device is interrupted so that changes can be made.

After exiting the main menu, operation is released again.

The main menu can be left manually using the arrow key  via the foam time. Alternatively, the control unit automatically switches to the operating menu after 60 s without any input. Any unsaved changes will be lost in this process.



## TIP!

**Only built-in “options” are shown in the display.**

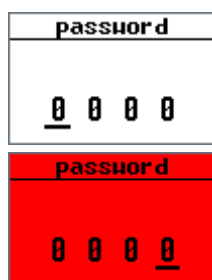

### 7.7.1 General password protection



Some functions are password-protected against unauthorised modification. Protected functions are marked with a padlock symbol .

The user password 0123 must be entered to be able to change these menus.

The entry is made in sequence depending on the digit position. The active number is marked with an underscore.

Use the arrow keys  and  to count the corresponding number up or down and confirm with the Enter key .

If the password is entered incorrectly (after selecting the last digit on the right), the display lights up red and the system jumps back to the main menu.

### 7.7.2 Activate/deactivate password protection

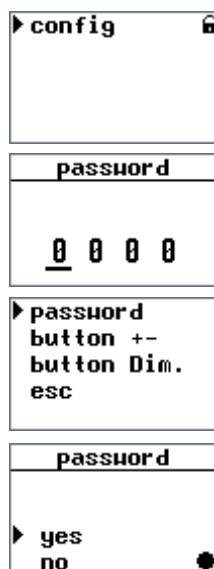

There are user menus that can be protected against changes by a password. This may be necessary if the device is placed in a freely accessible area and needs to be protected from unauthorised operation.

When password protection is activated, the following parameters are protected with a password:

- Emptying
- Language

Password protection is jointly activated or deactivated for these 2 menus.

Yes: The menus are protected by a password

No: The menus are not protected by a password

The menu for password protection can be found under “Config → Password”

The password is preset and cannot be changed.

**The password is: 0123**



## NOTICE

**The menus “Config” and “Reset” are always protected by the user password!**



## 7.7.3 Set foam time

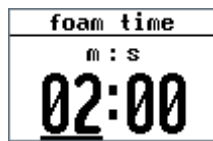

During this time, foam is generated and the massage guest is covered with foam.

Time is set in minutes and seconds.

## 7.7.4 Set rinse time



During this time, the massage guest is rinsed with water. Ensure that the water has the correct temperature!

Time is set in minutes and seconds.

The rinsing function is used to rinse the massage guest with water. At the same time, the foam generator and the foam line are rinsed with water and thus cleaned.

## 7.7.5 Emptying the foam line (option)

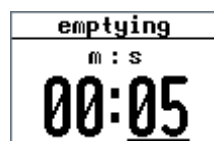

This menu only appears when **Emptying** function is activated. If the function is not activated, the “Option not installed” message appears.

The line can be emptied after each rinsing.

Solenoid valve:

After each rinsing, the Emptying valve is automatically opened for the set time. The foam line is emptied and the push button light is flashing.

The Emptying is only possible if a Emptying valve was put in during installation.

## 7.7.6 Output test

“Test functions” are used for function control in order to narrow down possible faults. For test functions, the time is set to 20 seconds and cannot be changed. The test function can be cancelled prematurely with the Enter key.

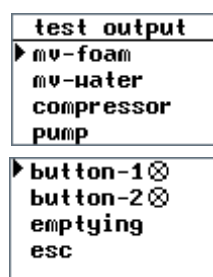

The submenus for the output test are called up here

## 7.7.6.1 Output test → MV foam

---

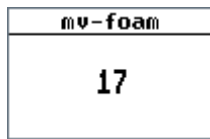

For function control  
Open the “Foam” solenoid valve  
Function:

- The “Foam” solenoid valve opens.
- The control LED on the solenoid valve lights up.

## 7.7.6.2 Output test → MV water

---

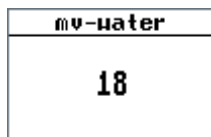

For function control.  
Open the “Water” solenoid valve.

Function:

- The “Water” solenoid valve opens. **Water runs out** of the shower head or the foam dispenser! If foam is still present in the line, it is automatically rinsed out.
- The control LED on the solenoid valve lights up.

## 7.7.6.3 Output test → Compressor

---

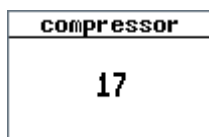

For function control.  
Switch on compressor.

Function:

- The compressor is running.

## 7.7.6.4 Output test → Pump

---

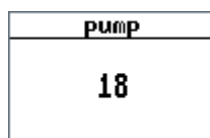

For function control.  
Start the peristaltic pump.

Function:

- The peristaltic pump is running.

## 7.7.6.5 Output test → Push button 1 and push button 2

---

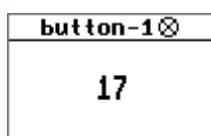

For function control.  
Check push button illumination.

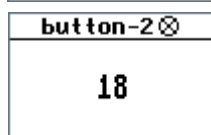

Function:

- The selected push button illumination lights up.

## 7.7.6.6 Output test → Emptying (accessory Emptying valve)

<b>emptying</b>
<b>18</b>

Only possible if the “Emptying” solenoid valve is connected.  
For function control.

Drain the foam line via the solenoid valve after rinsing it with water.

Function:

- The “Emptying” solenoid valve opens. The remaining water runs out of the Emptying valve, the shower head or the foam dispenser.
- The control LED on the solenoid valve lights up.

## 7.7.7 Input test

<b>test input</b>
op. contact ●
button-1 ○
button-2 ○

The active input signals are displayed here.

○ → no input signal

● → input signal is active

## 7.7.8 Set language

<b>language</b>
Deutsch
▶ English ●
Русский

Select the desired operating language for the display.

## 7.7.9 Set contrast

<b>contrast</b>
<b>8</b>

Set the desired contrast level for the display.

## 7.7.10 Information about the device

<b>FOAMDOS-U7</b>
<b>1.0.1</b>
<b>Sn: 000000</b>
<b>manuf. date</b>
<b>23.03.2023</b>

Information about the software version, serial number and date of manufacture.



### **NOTICE**

Have this information available for any support queries!

## 7.7.11 Reset

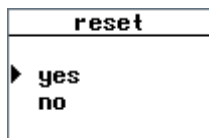

The Reset menu is always password-protected. The parameters can be reset to the factory settings here. Afterwards, the device behaves as it did when it was switched on for the first time; the start query occurs as described in *Chapter 7.5.1*.

yes: The device is reset to the factory settings. **The user password is: 0123**

no: The menu is exited without any changes to the settings.





### **NOTICE**

After the reset, the device starts with the start query. The values must be reentered. See *Chapter 7.5.1, page 30*.

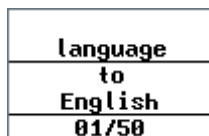
## 7.7.12 Display data log





The device saves the last 50 changes or faults. That information is displayed in this submenu.

- Select the **Data log** entry in the main menu and confirm with the Enter key .
- Use the arrow keys to scroll through the individual entries.
- Use the Enter key  to switch back to the main menu.

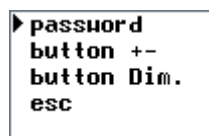
## 7.7.13 Config - General



The Config menu is always password-protected.

- Select the **Data log** entry in the main menu and confirm with the Enter key .
- Enter the password 0123 in the password dialogue and confirm with the Enter key .

The following settings can be made in the **Config** submenu:

- Password protection, see *Chapter 7.7.2, page 32*
- Push button polarity
- Push button dimming

For further procedure, see the following chapter

## 7.7.13.1 Config → push button dimming

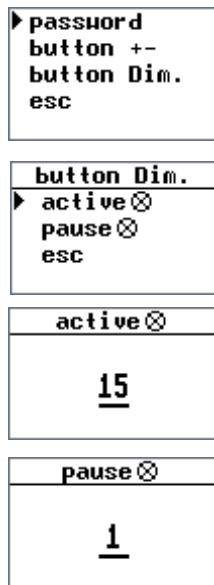

The Config menu is always password-protected.  
Switch to the `Push button dim.` submenu

The push button dimming is used to adjust the push button illumination.

The intensity of the push button illumination during operation (foam generation and rinsing) and during the pause time is set here.

## 7.7.13.2 Config → push button polarity (push button +/-)

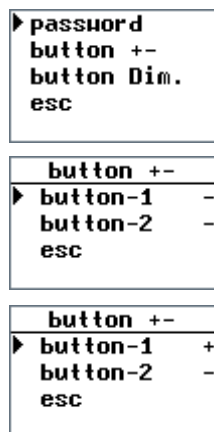

The Config menu is always password-protected.  
Switch to the `Push button +/-` submenu

There is a different setting for the push button illumination between operation of the device and during the pause time.

The polarity, i.e., plus side and minus side, of the push button illumination is **reversed** here. The function is important when using external push buttons.

## 7.8 Adjust the foam consistency

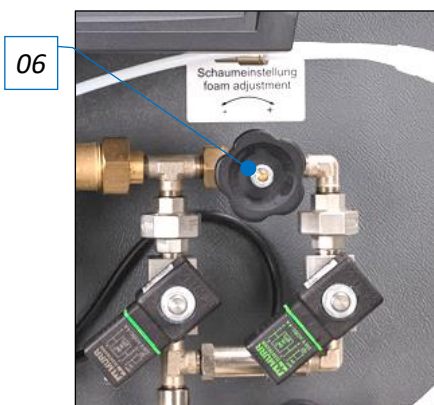

Fig. 22: Needle valve

The consistency of the massage foam can be changed by setting the water volume. The setting is done at the needle valve pos. 06.

### Turn clockwise:

The water flow is decreased, the foam becomes firmer.

### Turn counter-clockwise:

The water flow is increased, the foam becomes more liquid.

## 8 Maintenance / Care / Fault removal

### 8.1 Open/close the control housing

During fault removal, it may be necessary to open the control housing. See *Chapter 5.7.2, page 24*.



#### WARNING!

#### Danger of electric shock!

Dangerous electrical voltage! 230 Volt or 110 Volt, depending on the design

- All work on the device must be carried out by specialist personnel only!
- All electrical installations and any work on the device's electrical components must be carried out by authorised electricians only!
- Prior to starting work, disconnect the devices from the power supply and secure them against being reactivated!
- After corresponding electrical installation or repair, test all protective measures used (e.g., earthing resistance)!



#### ATTENTION!

#### Danger due to static charge!

This safety notice denotes electronic components that may be damaged by electrostatic discharges.

The generally accepted safety precautions for ESD-sensitive devices must be observed when handling the devices!

In particular, the following applies for work on the control board:

- Plug-in connectors must only be connected or removed when the power has been deactivated.
- As the person handling the device, please discharge yourself electrostatically for at least 5 seconds prior to directly touching the devices, e.g., by touching a grounded part of the system or by wearing an ESD antistatic wrist strap connected to ground!

### 8.2 Device maintenance



#### WARNING!

#### Danger of electric shock!

Dangerous electrical voltage! 230 Volt or 110 Volt, depending on the design

- All work on the device must be carried out by specialist personnel only!
- All electrical installations and any work on the device's electrical components must be carried out by authorised electricians only!
- Prior to starting work, disconnect the devices from the power supply and secure them against being reactivated!



## NOTICE

We recommend that you assign a specialist firm to carry out regular maintenance.

In order to ensure the proper function of the FOAMDOS V7, pay attention to the following points:

- Testing and maintenance in accordance with the maintenance protocol in Chapter 10.5 on page 49.
- Stocking of the required consumables. Pay attention to shelf life and storage time!
- Regular cleaning of the device

### 8.3 Check/change hose kit

The dosing hose in the pump is subject to mechanical and chemical stresses.

Therefore, the hose must be checked after each refilling of the foam concentrate in order to detect damage (e.g., cracks, discolouration) in due time and to replace the dosing hose.

The dosing hose must be replaced **at least every 12 months!**

#### Individual components of the peristaltic pump

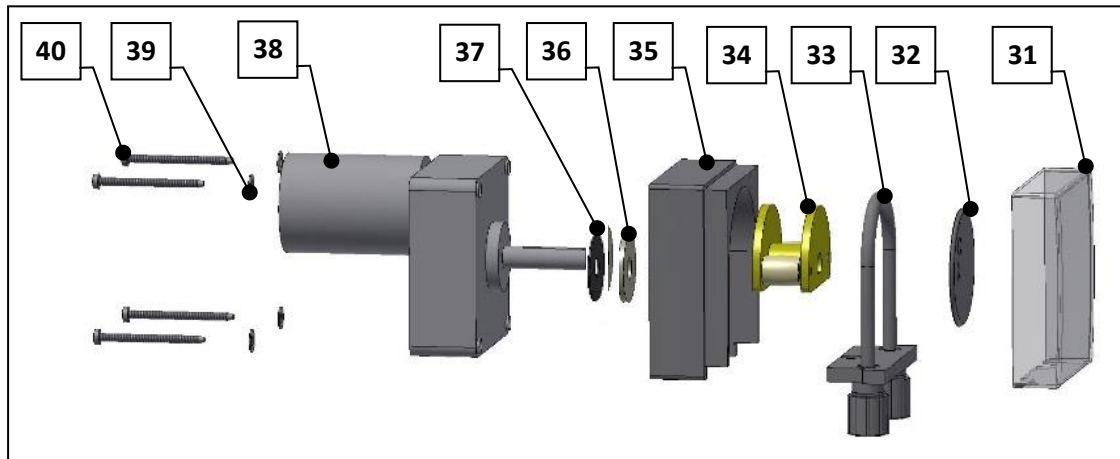

Fig. 23: Peristaltic pump individual parts

#### Key

31 Transparent pump cover	32 Safety disc
33 Hose bracket with dosing hose	34 Roller carrier
35 Pump casing	36 Sealing washer felt
37 Sealing washer EPDM	38 Gear motor
39 Flat washer	40 Screw

#### 8.3.1 Replace hose kit and roller carrier

See description in Chapter 6.3.2, page 26.

#### 8.3.2 Renew hose on hose bracket



## WARNING!

### Risk of crushing!



Injury to fingers (crushing) possible!

- **Only conduct the work when the device has been switched off and secured against being reactivated!**



## ATTENTION!

### Risk of damage due to an unsuitable hose!

- The new hose must match the disassembled hose in colour, size and marks!
- The hose must not be twisted when inserted!
- The markings on the hose ends must be visible in the front and centre (see Fig. 24)!

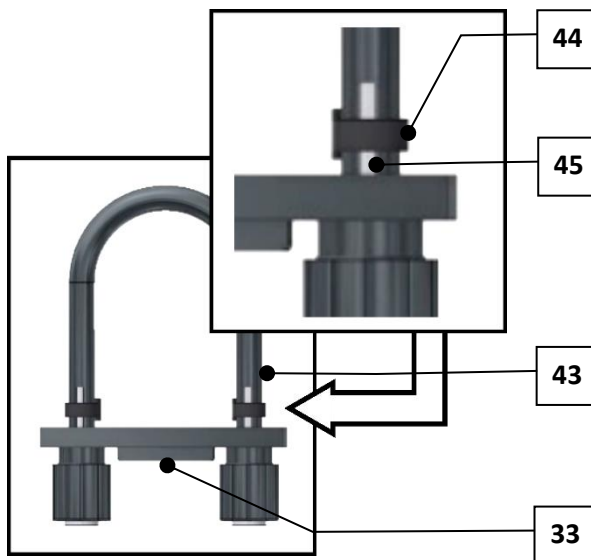

Fig. 24: Hose kit, marking

- Remove the hose kit (see *Chapter 6.3.2, page 26*).
- To replace the *dosing hose* (Pos. 43) at the hose bracket (Pos. 33), **carefully** cut open the hose clamp (Pos. 44) with a sharp knife or a pair of pliers!  
**Make sure you do not damage the hose nipples of the hose bracket in the process!**
- Push the new dosing hose onto the hose nipples so that the markings on the hose ends are visible in the front and centre! (Pos. 45)  
This ensures that the hose is not twisted.
- Fix the hose ends with new hose clamps and cut off the protruding ends of the hose clamp.
- Install the hose kit (see *Chapter 6.3.2, page 26*).

### 8.3.3 Dosing valves, renew valve rubber

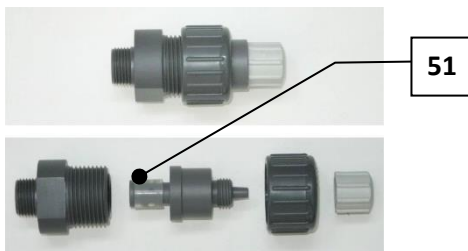

Fig. 25: Dosing valve

This description applies to both the foam concentrate dosing valve (pos. 10) and the air dosing valve (pos. 11).

- Unscrew the union nut of the dosing valve
- Remove the dosing valve insert
- Carefully remove the valve rubber (pos 51) from the tappet
- Push a new valve rubber onto the tappet
- Reassemble the dosing valve

## 8.4 Faults

### 8.4.1 General safety notices



## WARNING!

### Danger of electric shock!



**Dangerous electrical voltage! 230 Volt or 110 Volt, depending on the design**

- All work on the device must be carried out by specialist personnel only!
- All electrical installations and any work on the device's electrical components must be carried out by authorised electricians only!
- Prior to starting work, disconnect the devices from the power supply and secure them against being reactivated!



## WARNING!

**Risk of crushing!**



**Injury to fingers (crushing) possible!**

- Wear thin gloves when engaged in fault removal!

### 8.4.2 Fault removal

Error	Cause / effect	Action
The device cannot be switched on	<ul style="list-style-type: none"> <li>• Fuse defective</li> <li>• Mains switch defective</li> <li>• Power supply interrupted</li> </ul>	<ul style="list-style-type: none"> <li>• Check/renew fuse</li> <li>• Check mains switch</li> <li>• Check power supply</li> </ul>
Device without function	<ul style="list-style-type: none"> <li>• Incorrect setting</li> <li>• Fuse defective</li> <li>• Control board defective</li> <li>• Button plate not connected/adjusted/defective</li> </ul>	<ul style="list-style-type: none"> <li>• Check/reset settings</li> <li>• Renew fuse</li> <li>• Renew circuit board</li> <li>• Connect/adjust/renew button plate</li> </ul>
Solenoid valve without function	<ul style="list-style-type: none"> <li>• Fuse defective</li> <li>• Solenoid valve/coil defective</li> </ul>	<ul style="list-style-type: none"> <li>• Renew fuse</li> <li>• Check/renew solenoid valve</li> </ul>
Peristaltic pump without function	<ul style="list-style-type: none"> <li>• Fuse defective</li> <li>• Pump motor defective</li> </ul>	<ul style="list-style-type: none"> <li>• Renew fuse</li> <li>• Check/renew pump motor</li> </ul>
No foam dosing	<ul style="list-style-type: none"> <li>• Fuse defective</li> <li>• Peristaltic pump defective</li> <li>• Dosing hose worn</li> <li>• Roller carrier worn</li> <li>• Dosing valve blocked</li> <li>• Incorrect foam concentrate</li> </ul>	<ul style="list-style-type: none"> <li>• Check/renew fuse</li> <li>• Check/renew pump</li> <li>• Renew dosing hose</li> <li>• Renew roller carrier</li> <li>• Check/clean/renew dosing valve; only use original WDT dosing valves</li> <li>• Replace foam concentrate</li> </ul>
No pressure build-up	<ul style="list-style-type: none"> <li>• Compressor defective</li> <li>• Pressure lines leak</li> </ul>	<ul style="list-style-type: none"> <li>• Check/renew compressor</li> <li>• Check/renew lines</li> </ul>
Leakage at the peristaltic pump	<ul style="list-style-type: none"> <li>• Dosing hose defective</li> </ul>	<ul style="list-style-type: none"> <li>• Renew dosing hose</li> </ul>

## 9 Decommissioning / Storage / Disposal

### 9.1 Decommissioning



#### WARNING!

#### Risk of crushing!



#### Injury to fingers (crushing) possible!

- **Wear thin gloves when engaged in fault removal!**

Pay attention to the following notices when decommissioning the device:

- When decommissioning the device, empty it completely and protect it from frost!
- Switch off the device at the main switch for decommissioning.

#### Decommissioning for more than 30 days

#### Procedure

- a) Remove the suction lance from the canister.
- b) Close the canister.
- c) Rinse the foam line with water. (Press the “Rinse” button).
- d) Drain the foam concentrate from the suction line and the dosing valve and rinse them
- e) All components must be stored dry and cleaned.
- f) Remove the roller carrier of the peristaltic pump to prevent damage to the dosing hose. Procedure *see Chapter 6.3.2.*
- g) Open Emptying valve (accessory)
- h) Switch off/disconnect power supply

### 9.2 Storage

Pay attention to the following notices when storing the device:

- After decommissioning, store the device in a dry location protected from frost!
- Pay attention to the notices in *Chapter 3.5, page 16!*

### 9.3 Recommissioning



#### ATTENTION!

#### Damage due to incorrect commissioning!

- **Observe the sequence of the commissioning steps!**
- **Pay attention to the information in the commissioning protocol according to *Chapter 10.3, page 47!***

When recommissioning the device, follow the commissioning steps according to *Chapter 6, page 25* and pay attention to the points in the commissioning protocol!

## 9.4 Disposal



### ATTENTION!

#### Danger of environmental damage!



Undiluted foam concentrates are toxic to aquatic organisms, with long-term effects.

- Pay attention to the disposal regulations!
- Also pay attention to the safety data sheet!



### ATTENTION!

#### Environmental damage due to improper disposal!



- Pay attention to the national and local laws, ordinances and regulations regarding the disposal of mechanical and electronic components!

Pay attention to the following notices when disposing of the device:

- Thoroughly clean any dismantled parts prior to disposal.
- Used parts and operating materials must be disposed of in accordance with the regulations applicable at the site of operation, or they must be recycled.
- If operating materials are subject to special regulations, please pay attention to the corresponding information on the packaging.
- When in doubt, information may be obtained from the institution responsible for disposal at your location.

## 10 Documents

### 10.1 Declaration of conformity

<p>WDT Werner Dosiertechnik GmbH &amp; Co. KG                  Hettlinger Straße 17   D-86637 Wertingen                  Tel. 0049 8272 98697-0   Fax 0049 8272 98697-19                  info@werner-dosiertechnik.de   www.werner-dosiertechnik.de</p>			
<p><b>EG-Konformitätserklärung</b>  <b>EC declaration of conformity</b>  <b>Déclaration de conformité UE</b></p> <p>im Sinne der EG-Maschinenrichtlinie 2006/42/EG, Anhang II 1.A                  as defined in the ECMachinery Directive 2006/42 / EC, Annex II, Part 1A                  selon la directive européenne machines 2006/42 / CE, annexe II 1.A</p>			
<b>Hersteller</b>	WDT - Werner Dosiertechnik GmbH & Co. KG		
<b>Manufacturer</b>	Hettlinger Str. 17		
<b>Fabricant</b>	86637 Wertingen-Geratshofen		
<b>Beschreibung und Identifikation des Produktes:</b>			
<b>Description and identification of the product:</b>			
<b>Description et identification du produit :</b>			
Typenbezeichnung:		Art:	
• Dosiergerät Foamdos V6 und Foamdos V7		Maschine	
<b>Funktion:</b>	Erzeugung von Massageschaum für den Wellness-Bereich		
<b>Function:</b>	Production of foam for wellness massages in the wellness aerea		
<b>Fonction:</b>	Système de production de mousse de massage pour espaces bien-être		
<p><b>Es wird ausdrücklich erklärt, dass das Produkt allen einschlägigen Bestimmungen der folgenden EG-Richtlinien entspricht:</b>  <b>It is expressly stated that the product complies with all relevant provisions of the following EC directives</b>  <b>Il est explicitement dit que le produit est conforme à toutes les dispositions pertinentes des directives CE suivantes :</b></p>			
2006/42/EG	RICHTLINIE 2006/42/EG DES EUROPÄISCHEN PARLAMENTS UND DES RATES vom 17. Mai 2006 über Maschinen und zur Änderung der Richtlinie 95/16/EG (Neufassung)		
<p><b>Die folgenden harmonisierten Normen nach Artikel 7 (2) wurden angewandt:</b>  <b>The following harmonized standards as defined in Article 7 (2) were applied:</b>  <b>Les normes harmonisées suivantes selon l'article 7 (2) ont été appliquées :</b></p>			
EN ISO 12100:2010	Sicherheit von Maschinen - Allgemeine Gestaltungsleitsätze - Risikobeurteilung und Risikominderung		
EN ISO 13849-1:2015	Sicherheit von Maschinen – Sicherheitsbezogene Teile von Steuerungen – Teil 1: Allgemeine Gestaltungsleitsätze		
EN ISO 13849-2:2012	Sicherheit von Maschinen – Sicherheitsbezogene Teile von Steuerungen – Teil 2: Validierung		
EN 60204-1:2018	Sicherheit von Maschinen – Elektrische Ausrüstung von Maschinen – Teil 1: Allgemeine Anforderungen		
DIN EN1717:2000	Schutz des Trinkwassers vor Verunreinigungen in Trinkwasser-Installationen und allgemeine Anforderungen an Sicherungseinrichtungen zur Verhütung von Trinkwasserverunreinigungen durch Rückfließen;		
<p><b>Die in der Gemeinschaft ansässige Person, die für die Zusammenstellung der technischen Unterlagen bevollmächtigt ist:</b>  <b>The designated person who is authorized to draw up the technical documentation:</b>  <b>La personne établie dans la communauté qui est autorisée à constituer le dossier technique:</b></p>			
<b>Name:</b>	Werner Dosiertechnik GmbH & Co KG		
<b>Straße/Nr.:</b>	Hettlinger Straße 17		
<b>PLZ Stadt:</b>	86637 Wertingen		
Wertingen, 09. Mai 2023		 Unterschrift/signature Rainer Rieger, Director	
Ort/City/Place, Datum/Date			
			
CE DW 013-02 Konformitätserklärung Foamdos V6+V7.docx			

## 10.2 Wiring diagrams

Notice: The wiring diagrams can also be found near the device's control cabinet.

### FOAMDOS V7 , 230 Volt design

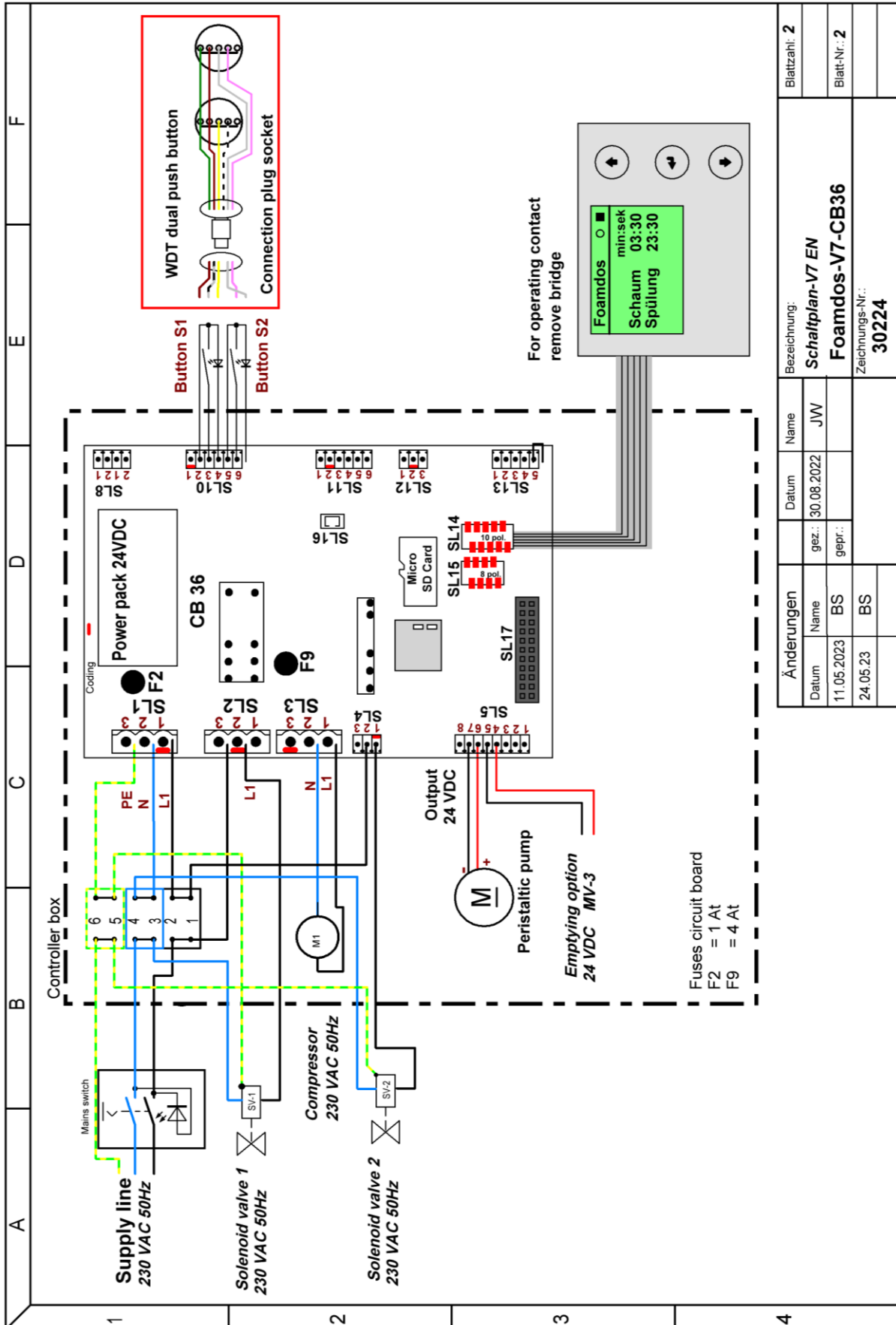

## FOAMDOS V7, 110 Volt design

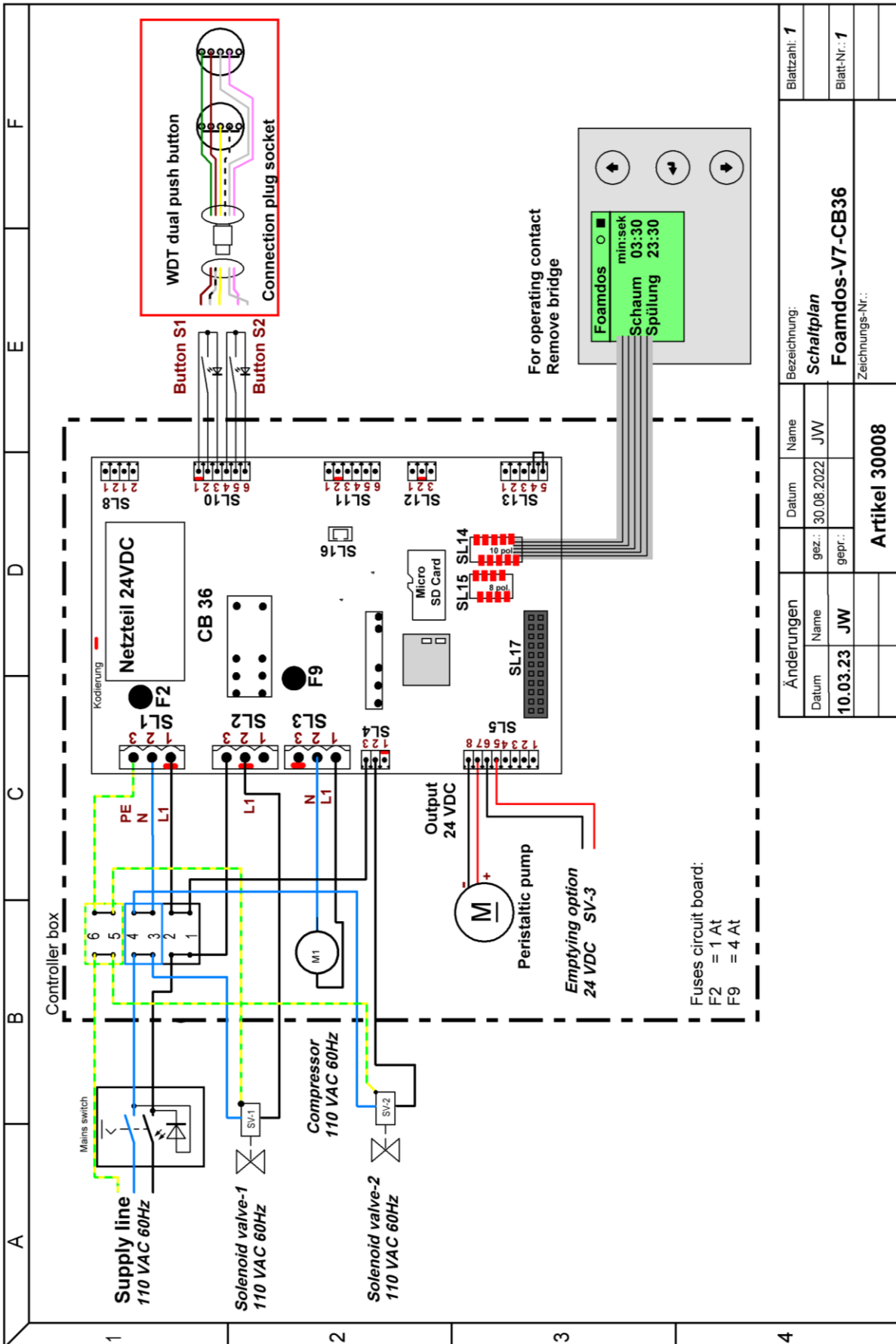

Änderungen		Bezeichnung:		Blattzahl: 1	
Datum	Name	Datum	Name	Blatt-Nr.: 1	
10.03.23	JW	30.08.2022	JW	Schaltplan	
				Foamdos-V7-CB36	
				Zeichnungs-Nr.:	
				Artikel 30008	

## 10.3 Commissioning protocol

This protocol is to be completed by the commissioning technician! Without a completed and signed commissioning protocol, all warranty claims become void!

The commissioning protocol can be found in the accompanying documentation in *Chapter 11*, page 50.

## 10.4 Operation data sheet



### **NOTICE**

During commissioning, enter the operating parameters in the operation data sheet!

Parameter	*	Factory setting	Setting range	Password possible	During commissioning, Date	Optimised during operation, Date
Language	-1-	German	DE, EN, FR	yes		
Foam time	-2-	02:00	00:05-10:00	no		
Rinse time	-3-	01:00	00:05-10:00	no		
Emptying		00:05	00:00-00:59	yes		
Contrast		8	1-15	no		
Password protection for user menu		ON	ON / OFF	yes		
Push button-1 +- Polarity		Minus	Minus / Plus	yes		
Push button-2 +- Polarity		Minus	Minus / Plus	yes		
Push button dimming operation		15	0-15	yes		
Push button dimming pause		0	0-15	yes		

\* : Sequence when switching on directly after a reset to the factory settings

Operation data sheet, --master copy--

Parameter	*	Factory setting	Setting range	Password possible	During commissioning, Date	Optimised during operation, Date
Language	-1-	German	DE, EN, FR	yes		
Foam time	-2-	02:00	00:05-10:00	no		
Rinse time	-3-	01:00	00:05-10:00	no		
Emptying		00:05	00:00-00:59	yes		
Contrast		8	1-15	no		
Password protection for user menu		ON	ON / OFF	yes		
Push button-1 +- Polarity		Minus	Minus / Plus	yes		
Push button-2 +- Polarity		Minus	Minus / Plus	yes		
Push button dimming operation		15	0-15	yes		
Push button dimming pause		0	0-15	yes		

Parameter	*	Factory setting	Setting range	Password possible	During commissioning, Date	Optimised during operation, Date
Language	-1-	German	DE, EN, FR	yes		
Foam time	-2-	02:00	00:05-10:00	no		
Rinse time	-3-	01:00	00:05-10:00	no		
Emptying		00:05	00:00-00:59	yes		
Contrast		8	1-15	no		
Password protection for user menu		ON	ON / OFF	yes		
Push button-1 +- Polarity		Minus	Minus / Plus	yes		
Push button-2 +- Polarity		Minus	Minus / Plus	yes		
Push button dimming operation		15	0-15	yes		
Push button dimming pause		0	0-15	yes		



## 10.5 Maintenance protocol



### **NOTICE**

Carry out the specified maintenance tasks in order to protect any warranty claims!

The maintenance protocol can be found in the accompanying documentation in *Chapter 11*, page 50.

## 10.6 Spare parts



### **ATTENTION!**

#### **Damage due to unapproved spare parts!**

- **Only use spare parts approved by the manufacturer!**
- **Only order spare parts from your service partner or your specialist dealer.**

### 10.6.1 Spare parts list

Device	Pos.	Designation	Code no. WDT
<b>Control unit</b>		Fuse bag 2x4 A Tr, round 8.3 x 8	26416
		Fuse bag 2x500 mA Tr round 8.3 x 8	27074
		Control unit NT 35 fully loaded	26704
		Control board HMI NT-35	26538
<b>Dosing technology</b>		Peristaltic pump Sa 4.8 Ph cpl-oSbr	28229
		Pump cover transparent	14259
		Safety disc grey	13633
		Hose kit 4.8x1.6	13414
		Hose bracket with hose 4.8x1.6	12703
		Suction set d12	12278
		Dosing valve air 3/8"	20503
		Dosing valve foam concentrate 3/8"	20502
		Diaphragm pump 230 Volt (compressor)	24269
		Diaphragm pump 110 Volt (compressor)	30004
		Solenoid valve 230 Volt, water/foam/emptying	27591
		Solenoid valve 110 Volt, water/foam/emptying	29923
		Solenoid valve plug with LED	13082
<b>Push button</b>		Button plate 2x with Piezo push button	19012
		Push button with ring illumination in blue Piezo	18741
		Nameplate foam	17525
	Nameplate water	17526	
<b>Consumables</b>		Foam concentrate Hay flower 10 litres	18347
		Foam concentrate Rose 10 litres	15455

### 10.6.2 Wear parts list

Device	Pos.	Designation	Code no. WDT
	--	Hose kit SA 4.8x1.6-PH-SA	13414
	--	Roller carrier for peristaltic pump yellow	12609
	51	Valve rubber for dosing valve	28732

### 10.6.3 List of consumables

Foam concentrate: A list of current foam concentrates can be obtained from WDT.



# Commissioning Protocol IP-071-EN

## Foamdos V6 + V7



This protocol is to be completed by the commissioning technician! Without a completed and signed commissioning protocol, all warranty claims become void!

Object: \_\_\_\_\_ Date: \_\_/\_\_/\_\_\_\_

City, street, house number: \_\_\_\_\_

Device type: \_\_\_\_\_ Year of manufacture: \_\_\_\_\_ Serial number: \_\_\_\_\_

	Activity	Completed	Comment
<b>1</b>	<b><u>Commissioning</u></b>		
1.1	Device checked for correct installation	<input type="checkbox"/>	
1.2	Commissioning conducted according to Operating Instructions (Chapter 6)	<input type="checkbox"/>	
1.3	Thermostatic mixer (option) set	<input type="checkbox"/>	
1.4	Control parameters adjusted and entered in the operating data sheet (Chapter 9.4 of the Operating Instructions)	<input type="checkbox"/>	
1.5	Canister with foam concentrate and suction lance connected	<input type="checkbox"/>	
1.6	Device checked for correct operation	<input type="checkbox"/>	
1.7	Device and lines checked for leaks	<input type="checkbox"/>	
<b>2</b>	<b><u>Other</u></b>		
2.1	Operating Instructions reviewed and handed over	<input type="checkbox"/>	
2.2	Service and operating personnel instructed	<input type="checkbox"/>	

Additional remarks:

---



---



---



---



---



---



---



---



---



---



---

Commissioning and instruction carried out by: .....

Instructed persons: .....

Signature of commissioner:.....

Countersigned by operator: .....



# Maintenance Protocol WP-075-EN

## Foamdos V6 + V7



This protocol is to be completed by the maintenance technician! We reserve the right to determine the warranty conditions when no completed and signed maintenance protocol is available.

Object:..... Maintenance year: 20\_\_

City, street, house number: .....

Device type: ..... Year of manufacture:..... Serial number: .....

	Activity	Maintenance interval in	Month												Comment / additional tasks	
			Month 1	Month 2	Month 3	Month 4	Month 5	Month 6	Month 7	Month 8	Month 9	Month 10	Month 11	Month 12		
<b>1</b>	<b><u>Water supply part</u></b>															
1.1	Check device for leaks	3			<input type="checkbox"/>				<input type="checkbox"/>						<input type="checkbox"/>	
1.2	Activate valves, check for function and leaks	3			<input type="checkbox"/>				<input type="checkbox"/>						<input type="checkbox"/>	
<b>2</b>	<b><u>Dosing technology</u></b>															
2.1	Check the peristaltic pump's hose	1	<input type="checkbox"/>	<input type="checkbox"/>	<input type="checkbox"/>	<input type="checkbox"/>	<input type="checkbox"/>	<input type="checkbox"/>	<input type="checkbox"/>	<input type="checkbox"/>	<input type="checkbox"/>	<input type="checkbox"/>	<input type="checkbox"/>	<input type="checkbox"/>	<input type="checkbox"/>	
2.2	Check entire dosing technology for leaks	3			<input type="checkbox"/>				<input type="checkbox"/>						<input type="checkbox"/>	
2.3	Check compressor function; renew, if necessary	6							<input type="checkbox"/>						<input type="checkbox"/>	
2.4	Renew the peristaltic pump's hose	12													<input type="checkbox"/>	
2.5	Renew sealing rubber for the "Foam" dosing valve	12													<input type="checkbox"/>	
2.6	Renew sealing rubber for the "Flush" dosing valve	12													<input type="checkbox"/>	
<b>3</b>	<b><u>Foam / Flushing withdrawal point</u></b>															
3.1	Visual check; clean / decalcify, if necessary	1	<input type="checkbox"/>	<input type="checkbox"/>	<input type="checkbox"/>	<input type="checkbox"/>	<input type="checkbox"/>	<input type="checkbox"/>	<input type="checkbox"/>	<input type="checkbox"/>	<input type="checkbox"/>	<input type="checkbox"/>	<input type="checkbox"/>	<input type="checkbox"/>	<input type="checkbox"/>	
<b>4</b>	<b><u>Control unit</u></b>															
4.1	Check electric cables for damage	12													<input type="checkbox"/>	
<b>5</b>	<b><u>Other Tasks</u></b>															
5.1	Clean the system	1	<input type="checkbox"/>	<input type="checkbox"/>	<input type="checkbox"/>	<input type="checkbox"/>	<input type="checkbox"/>	<input type="checkbox"/>	<input type="checkbox"/>	<input type="checkbox"/>	<input type="checkbox"/>	<input type="checkbox"/>	<input type="checkbox"/>	<input type="checkbox"/>	<input type="checkbox"/>	

Additional remarks:

---



---



---



---



---



---

Maintenance carried out and device checked for function: \_\_\_\_\_ Date: \_\_\_\_\_  
Signature

Countersigned by operator: \_\_\_\_\_  
Signature



**Assembly and sealing of the flush mounted box V2 for push button plates**



**CAUTION !**

**Before starting to work, make the electrical lines volt free and protect them against new connection! Wear protective clothes!**



**1 Assembly in building panels**



a) Install the empty conduit at the required place!  
**Diameter empty conduit type 32 (ID 25mm)**  
**Bend radius min. 10cm**

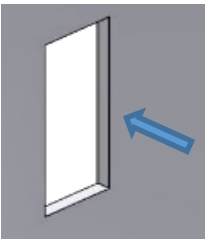

b) Cut out construction plate  
 Dimensions:  
 1-fold: HxWxD min. 100x67x55mm  
 2-fold: HxWxD min. 133x 67x55mm  
 3-fold: HxWxD min. 166x 67x55mm  
 4-fold: HxWxD min. 200x 67x55mm

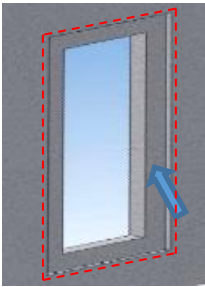

c) Cut a recess to sink the sealing flange with a depth of 3mm  
 Dimensions:  
 1-fold: HxW min. 130x97mm  
 2-fold: HxW min. 163x97mm  
 3-fold: HxW min. 196x97mm  
 4-fold: HxW min. 229x97mm

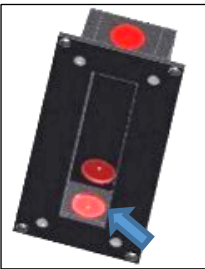

d) Break out an orifice for the empty conduit connection at the desired rated break point

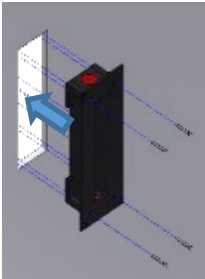

e) Install the flush mounted box and fix with 4 screws if necessary

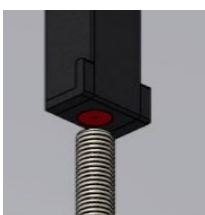

f) Connect the empty conduit onto the flush mounted box and insert cables

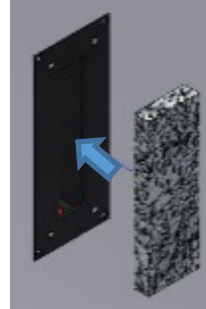

g) Place the supplied construction protection cap in the flush mounted box

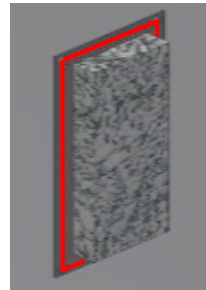

h) Apply sealant for vapour barrier foil



i) Adapt and adhere the vapour barrier foil  
**No humidity may penetrate!**

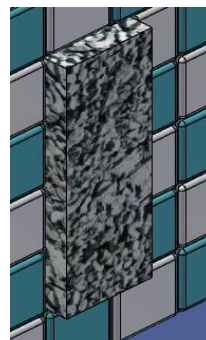

j) Tile the flush mounted box until the construction protection cap

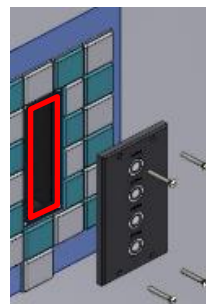

k) Take out the protection cap  
 Clamp the push button plate.  
Seal the push button plate against the flush mounted box: apply appropriate sealant on the flush mounted box and fix with 4 screws

**No humidity may penetrate!**

## EN - Additional sheet: flush mounted box V2

### 2 Installation in brickwork

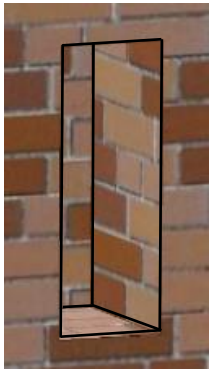

a) Chisel out brickwork for flush mounted box and empty conduit  
**Diameter empty conduit type 32 (ID 25mm)**  
**Bend radius min. 10cm**

Dimensions for break out works  
 1-fold: HxWxD min. 105x72x60mm  
 2-fold: HxWxD min. 138x72x60mm  
 3-fold: HxWxD min. 171x72x60mm  
 4-fold: HxWxD min. 205x72x60mm

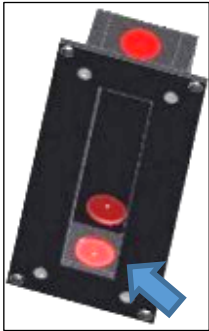

b) Break out an orifice for the empty conduit connection to the desired rated break point

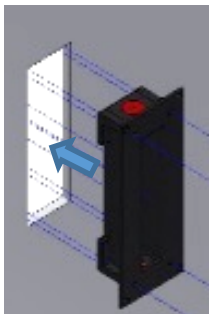

c) Install the flush mounted box and the empty conduit with electrician cast or building foam in the wall, approximately 20 mm protruding due to flush system

Insert cable



d) Install the supplied construction protection cap in the flush mounted box

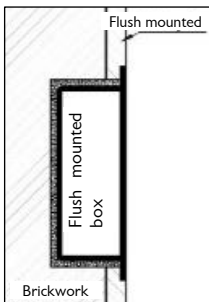

e) Plaster the brickwork so that the flush mounted box flushes with the plaster.

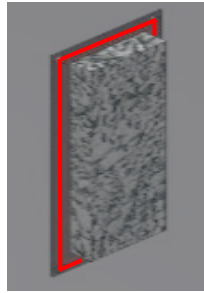

f) Apply sealant for vapour barrier foil



g) Adhere vapour barrier foil  
**No humidity may penetrate!**

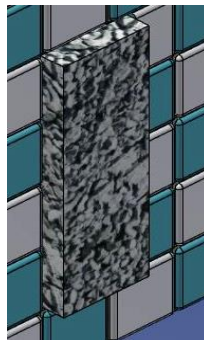

h) Enter the flush mounted box until the construction protection cap

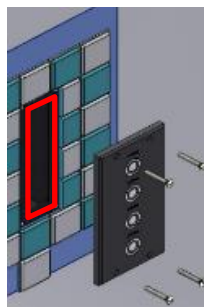

i) Remote protection cap  
 Clamp the push button plate.  
Seal the push button plate against the flush mounted box: apply appropriate sealant on the flush mounted box and fix with 4 screws

**No humidity may penetrate!**